

Application

Model HCD-120 is a heavy duty industrial control damper with a flanged frame. It is designed to control airflow and provide shut off in HVAC or industrial process control systems. A variety of optional features makes model HCD-120 extremely versatile, allowing its capabilities to be tailored to the application. This model is available with parallel or opposed blade action.

Ratings (see page 2 and 3 for specific limitations)

Velocity	Up to 3000 fpm (15.2 m/s)
Temperature	-40° to 400°F (-40° to 204°C)
Pressure	Up to 8.5 in. wg (2.1 kPa) - differential pressure

Construction

	Standard	Optional
Frame Depth	8 in. (203 mm)	10 in. (254 mm)
Frame Material	Galvanized steel	304SS, 316SS
Frame Type	Flanged channel	-
Frame Thickness	14 ga. (2 mm)	10 ga. (3.5 mm), 12 ga. (2.7 mm)
Flange Width (D)	2 in. (51 mm)	1 ½ in. (38 mm), 2 ½ in. (64 mm), 3 in. (76 mm)
Blade Action	Parallel	Opposed
Blade Material	Galvanized steel	304SS, 316SS
Blade Seals	None	EPDM, Silicone
Blade Thickness	16 ga. (1.5 mm)	-
Blade Type	3V	-
Linkage	Plated steel	304SS, 316SS
Jamb Seals	None	301SS, 316SS
Axle Diameter	½ in. (12.7mm)	-
Axle Bearing	Stainless steel sleeve	-
Axle Material	Plated steel	316SS
Axle Seals	None	-
Paint Finishes	None	Hi Pro Polyester, Hi Temperature Silver, Industrial Epoxy
Mounting Holes	None	Standard, Standard with corner holes



* Actual Inside Dimension. The W dimension is ALWAYS parallel with the damper blade length.

Damper linkage and axles may extend beyond the damper flange based on the configuration of selectable options. Consult factory for dimensions.

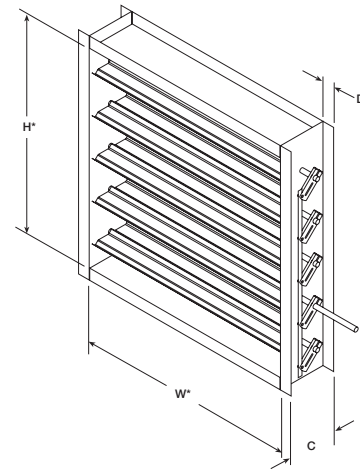

Size Limitations

W x H	Minimum Size	Maximum Size	
		Single Section	Multi - Section
Inches	6 ½ x 5	48 x 96	96 x 96
mm	165 x 127	1219 x 2438	2438 x 2438

Options:

- Wide range of actuators available
- Vertical Blade Orientation

Limitations

Pressure Limitations

The chart at the right shows conservative pressure limitations based on a maximum blade deflection of $w/360$.

Temperature Limitations

Blade seals: Silicone -40° to 400°F (-40° to 204°C)
EPDM -20° to 250°F (-29° to 121°C)

Jamb seals: Flexible stainless steel -40° to 400°F
(-40° to 204°C)

For higher temperatures, consult factory.

Velocity Limitations

The chart at far right shows velocity limitations based on damper size.

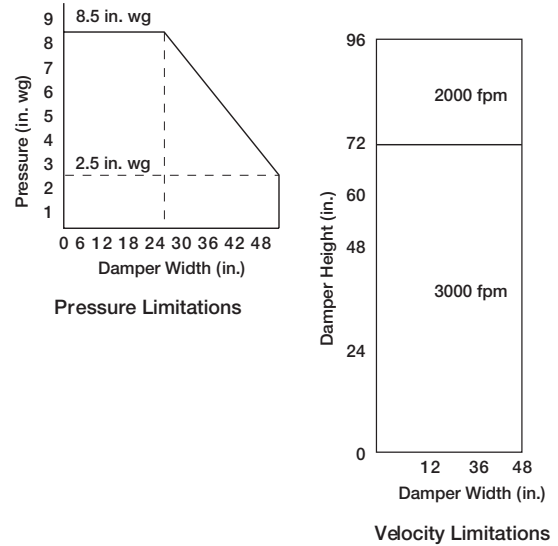

Pressure Drop Data

This pressure drop data was conducted in accordance with AMCA Standard 500-D using the three configurations shown. All data has been corrected to represent standard air at a density of .075 lb/ft³ (1.2 kg/m³).

Actual pressure drop found in any HVAC system is a combination of many factors. This pressure drop information along with an analysis of other system influences should be used to estimate actual pressure losses for a damper installed in a given HVAC system.

AMCA Test Figures

Figure 5.3 illustrates a fully ducted damper. This configuration has the lowest pressure drop of the three test configurations because the entrance and exit losses are minimized by straight duct runs upstream and downstream of the damper.

Figure 5.2 illustrates a ducted damper exhausting air into an open area. This configuration has a lower pressure drop than Figure 5.3 because the entrance losses are minimized by a straight duct run upstream of the damper.

Figure 5.5 illustrates a plenum mounted damper. This configuration has the highest pressure drop because of the high entrance and exit losses due to the sudden changes of area in the system.

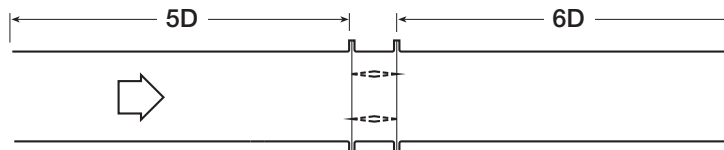

Fig. 5.3

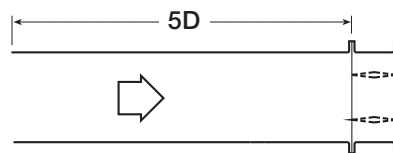

Fig. 5.2

$$D = \sqrt{\frac{4(W)(H)}{3.14}}$$

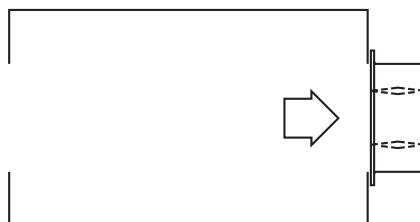
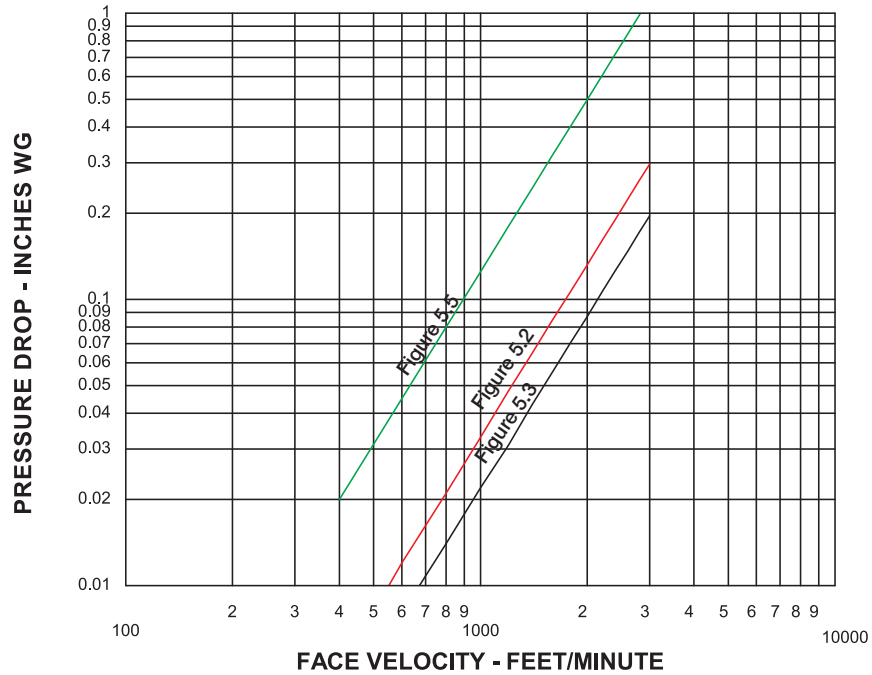

Fig. 5.5

Pressure Drop and Leakage Data

Pressure Drop

36 x 36 in. Damper
(914mm x 914mm)



Leakage Data

Damper leakage (with blades fully closed) varies based on the type of low leakage seals applied. Model HCD-120 is available with no jamb seals (standard) or with stainless steel jamb seals and EPDM, or silicone rubber blade seals. Leakage testing was conducted in accordance with AMCA Standard 500-D and is expressed as CFM per sq. ft. of damper face area. All data has been corrected to represent standard air at a density of .075 lb/ft³ (1.2 kg/m³).

Leakage

36 x 36 in. (914mm x 914mm) Damper
(based on 5 in. lb/ft² of torque)

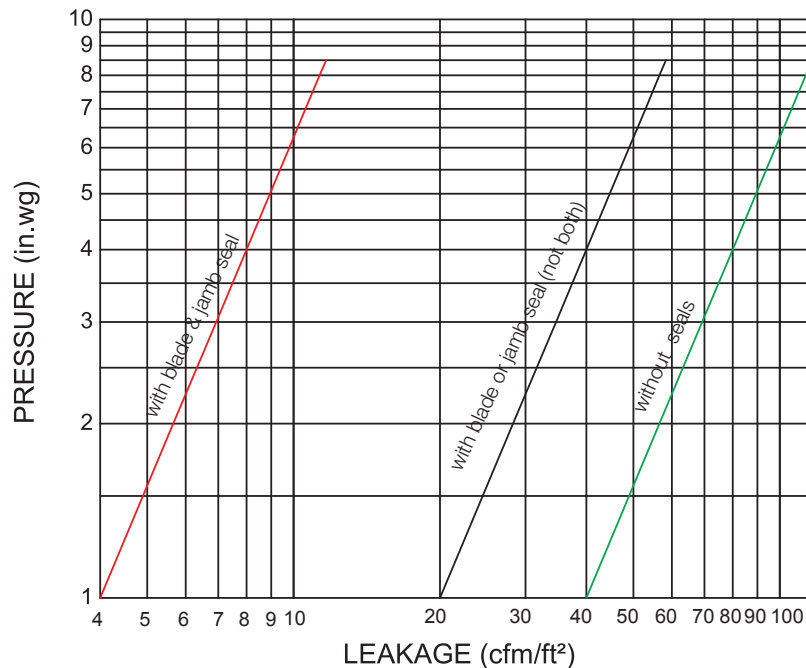

Mounting Holes

Bolt holes are available as an option. The standard pattern is $\frac{7}{16}$ in. (11mm) diameter holes (M dimension) spaced 6 in. (152mm) on center (L dimension). Custom bolt hole patterns are available. Contact factory for the limitations.

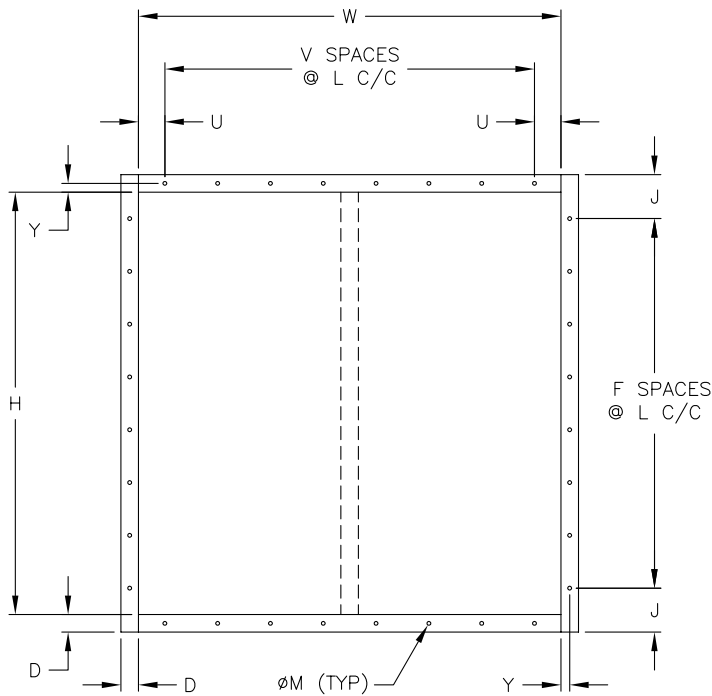

Standard Mounting Hole Pattern
Typical for single or double wide panel

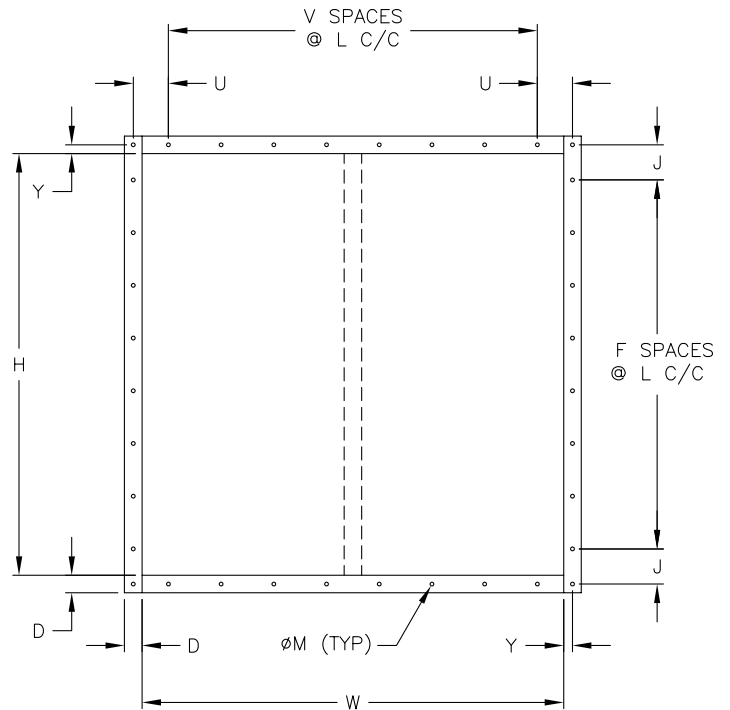

Standard Mounting Hole Pattern with Corner Holes
Typical for single or double wide panel

Document Links

[Installation Instructions](#)

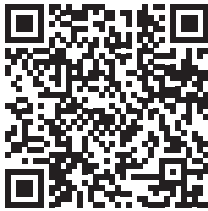

[Heavy Duty/Industrial Damper Catalog](#)



[Heavy Duty and Industrial
Product Selection Guide](#)



[Warranty](#)

