

### Application

Model HCD-135 is a heavy duty industrial control damper with a flanged frame. It is designed to control airflow and provide shut off in HVAC or industrial process control systems. A variety of optional features makes model HCD-135 extremely versatile, allowing its capabilities to be tailored to the application. This model is available with parallel or opposed blade action.

### Ratings

<b>Pressure</b>	Up to 8½ in. wg (2.1 kPa) - differential pressure
<b>Velocity</b>	Up to 4000 fpm (20.3 m/s)
<b>Temperature</b>	-40° to 250° F (-40 to 121°C). Temperatures over 250°F (121° C) require special blade end clearance.

### Construction

	Standard	Optional
<b>Frame Depth (C)</b>	8 in. (203 mm)	10 in. (254 mm)
<b>Frame Material</b>	Galvanized steel	304SS, 316SS
<b>Frame Thickness</b>	14 ga. (2 mm)	10 ga. (3.5 mm) 12 ga. (2.7 mm)
<b>Frame Type</b>	Flanged channel	-
<b>Flange Width(D)</b>	2 in. (51mm)	1½ in. (38mm) 2½ in. (64mm) 3 in. (76mm)
<b>Blade Action</b>	Parallel	Opposed
<b>Blade Material</b>	Galvanized steel	304SS, 316SS
<b>Blade Seals</b>	Silicone	EPDM
<b>Blade Thickness</b>	20 ga. (1mm) double skin	-
<b>Blade Type</b>	Insulated Fabricated Airfoil	-
<b>Linkage</b>	Plated steel	304SS, 316SS
<b>Axle Bearings</b>	Stainless steel sleeve	-
<b>Axle Diameter</b>	½ in. (12.7mm)	-
<b>Axle Material</b>	Plated steel	316SS
<b>Axle Seals</b>	None	-
<b>Jamb Seals</b>	301SS	316SS
<b>Mounting Holes</b>	None	Standard; Standard with corner holes



Optional actuator shown.

\* Actual Inside Dimension. The W dimension is ALWAYS parallel with the damper blade length.

Damper linkage and axles may extend beyond the damper flange based on the configuration of selectable options. Consult factory for dimensions.

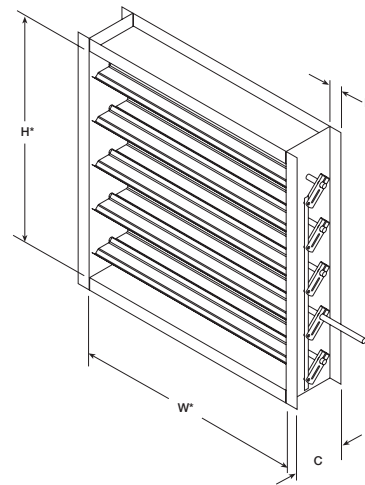

### Size Limitations

W x H	Minimum Size	Maximum Size	
		Single Section	Multi - Section
<b>Inches</b>	10 x 5	60 x 96	120 x 96
<b>mm</b>	254 x 127	1524 x 2438	3048 x 2438

### Options:

- Wide range of actuators available
- Vertical Blade Orientation

# Performance Data

## Pressure Limitations

The chart at the right shows conservative pressure limitations based on a maximum blade deflection of  $w/360$ .

## Temperature Limitations

- Blade seals:** Silicone -40° to 400°F (-40° to 204°C)  
EPDM -20° to 250°F (-29° to 121°C)
- Jamb seals:** Flexible stainless steel -40° to 400°F (-40° to 204°C)

For higher temperatures, consult factory.

## Velocity Limitations

The chart at far right shows velocity limitations based on damper size.

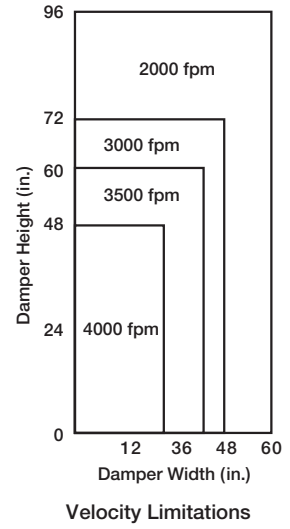
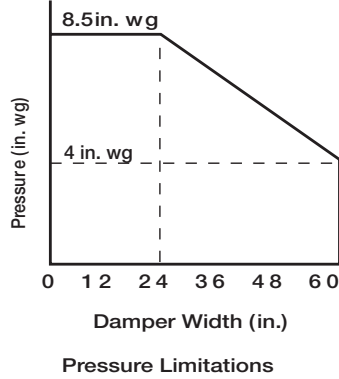

## Leakage Data

Damper leakage (with blades fully closed) varies based on the type of low leakage seals applied. Model HCD-135 is available with no jamb seals (standard) or with stainless steel jamb seals and EPDM, or silicone rubber blade seals. Leakage testing was conducted in accordance with AMCA Standard 500-D and is expressed as CFM per sq. ft. of damper face area. All data has been corrected to represent standard air at a density of .075 lb/ft<sup>3</sup> (1.2 kg/m<sup>3</sup>).

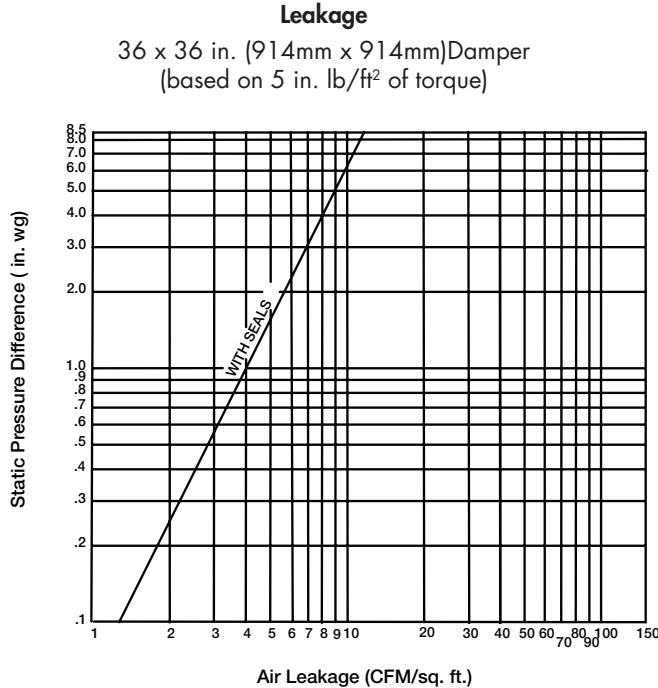

## Pressure Drop Data

This pressure drop data was conducted in accordance with AMCA Standard 500-D using the three configurations shown. All data has been corrected to represent standard air at a density of .075 lb/ft<sup>3</sup> (1.2 kg/m<sup>3</sup>).

Actual pressure drop found in any HVAC system is a combination of many factors. This pressure drop information along with an analysis of other system influences should be used to estimate actual pressure losses for a damper installed in a given HVAC system.

### AMCA Test Figures

**Figure 5.3** illustrates a fully ducted damper. This configuration has the lowest pressure drop of the three test configurations because the entrance and exit losses are minimized by straight duct runs upstream and downstream of the damper.

**Figure 5.2** illustrates a ducted damper exhausting air into an open area. This configuration has a lower pressure drop than Figure 5.5 because the entrance losses are minimized by a straight duct run upstream of the damper.

**Figure 5.5** illustrates a plenum mounted damper. This configuration has the highest pressure drop because of the high entrance and exit losses due to the sudden changes of area in the system.

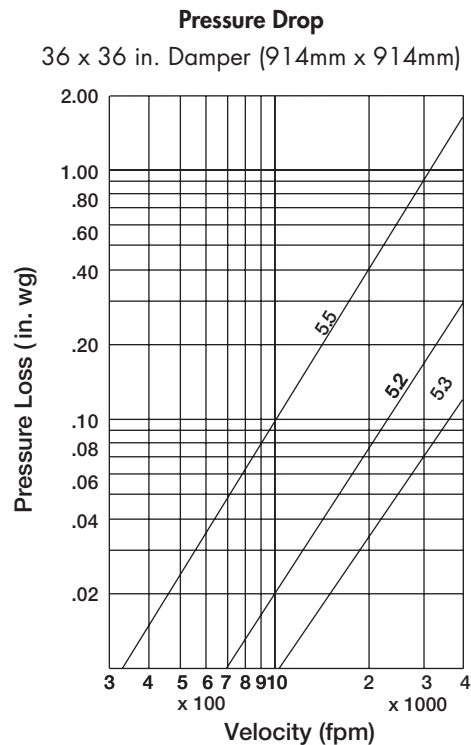
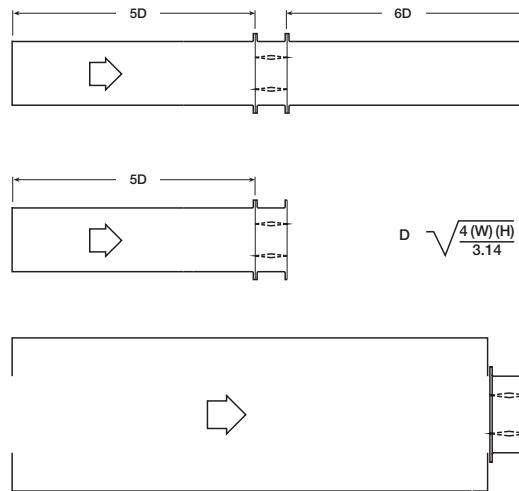

# Mounting Holes

Bolt holes are available as an option. The standard pattern is  $\frac{7}{16}$  in. (11mm) diameter holes (M dimension) spaced 6 in. (152mm) on center (L dimension). Custom bolt hole patterns are available. Contact factory for the limitations.

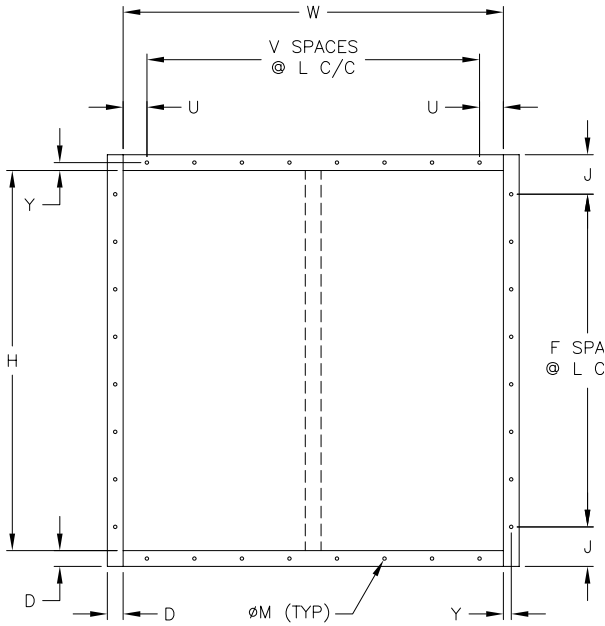

Standard Mounting Hole Pattern  
Typical for single or double wide panel

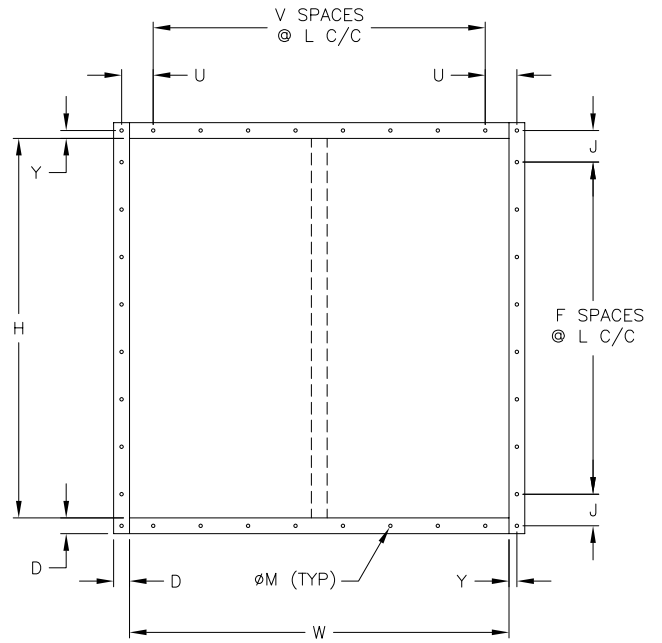

Standard Mounting Hole Pattern with Corner Holes  
Typical for single or double wide panel

# Document Links



[INSTALLATION](#)



[CATALOG](#)



[HD PRODUCT GUIDE](#)



[SELECTION GUIDE](#)



[WARRANTY](#)



Copyright © 2024 Venco Products  
HCD-135, R5, March 2024

Venco Products reserves the right to make product changes without notice.