

Application

Model HCD-230LE is a heavy duty flanged frame style industrial control damper with fabricated airfoil blades. It is designed to control airflow and provide shutoff in Vektor Lab Exhaust systems. This model is available with parallel or opposed blade action.

Ratings

Pressure*

Up to 15 in. wg (3.7 kPa) - differential pressure

Velocity*

Up to 5000 fpm (25.4 m/s)

Temperature*

-40 to 250°F (-40 to 121°C). Consult factory for other temperatures.

Construction

	Standard	Optional
Frame Depth (C)	8 in. (203mm)	-
Frame Material	Galvanized Steel	304SS, 316SS
Frame Type	Flanged Channel	Tray Jamb
Frame Thickness	14 ga. (2mm)	10 ga. (3.5mm) 12 ga. (2.7mm)
Flange Width (D)	2 in. (51mm)	-
Blade Action	Parallel (Isolation) Opposed (Bypass)	-
Blade Material	Galvanized Steel	304SS, 316SS
Blade Seals	Silicone	-
Blade Thickness	16 ga. (1.5mm)	-
Blade Type	Fabricated Airfoil	
Linkage	Plated Steel	304SS, 316SS
Jamb Seals	316SS	-
Axle Diameter	¾ in. (19mm)	-
Axle Bearing	Stainless Steel Sleeve	-
Axle Material	303SS	316SS
Axle Seals	None	-
Paint Finishes	None	Hi Pro Polyester
Mounting Holes	Standard	-

Features:

- Wide range of actuators available

Options:

- Blade Seal Replacement

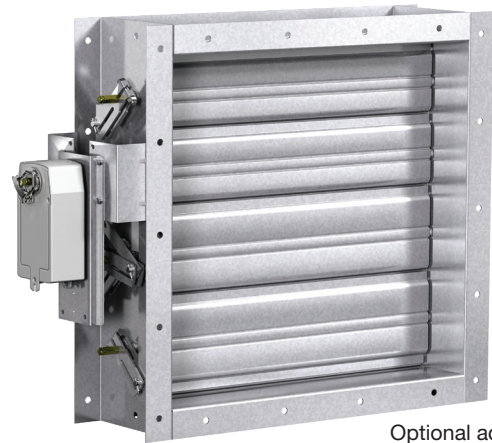

Optional actuator shown.

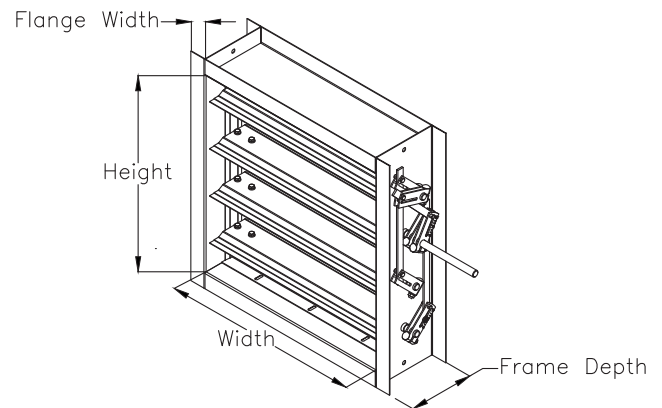

* Actual Inside Dimension. The W dimension is ALWAYS parallel with the damper blade length.

Damper linkage and axles may extend beyond the damper flange based on the configuration of selectable options. Consult factory for dimensions.

Size Limitations

WxH	Minimum Size	Maximum Size	
		Single Section	Multi-Section
Inches	6½ x 6	63 x 63	78 x 75⅞
mm	165 x 152	1600 x 1600	1981 x 1927

Frame Thickness*	Height less than or equal to 72 in. (1829 mm)	Height greater than 72 in. (1829 mm)
Width less than or equal to 60 in. (1524 mm)	14 ga. (2 mm)	14 ga. (2 mm)
Width greater than 60 in. (1524 mm) and less than or equal to 96 in. (2438 mm)	12 ga. (2.7 mm)	12 ga. (2.7 mm)
Width greater than 96 in. (2438 mm)	10 ga. (3.5 mm)	10 ga. (3.5 mm)

Pressure Drop

This pressure drop data was conducted in accordance with AMCA Standard 500-D using the three configurations shown. All data has been corrected to represent standard air at a density of .075 lb/ft³ (1.2 kg/m³).

Actual pressure drop found in any HVAC system is a combination of many factors. This pressure drop information along with an analysis of other system influences should be used to estimate actual pressure losses for a damper installed in a given HVAC system.

AMCA Test Figures

Figure 5.3 illustrates a fully ducted damper. This configuration has the lowest pressure drop of the three test configurations because the entrance and exit losses are minimized by straight duct runs upstream and downstream of the damper.

Figure 5.2 illustrates a ducted damper exhausting air into an open area. This configuration has a lower pressure drop than Figure 5.5 because the entrance losses are minimized by a straight duct run upstream of the damper.

Figure 5.5 illustrates a plenum mounted damper. This configuration has the highest pressure drop because of the high entrance and exit losses due to the sudden changes of area in the system.

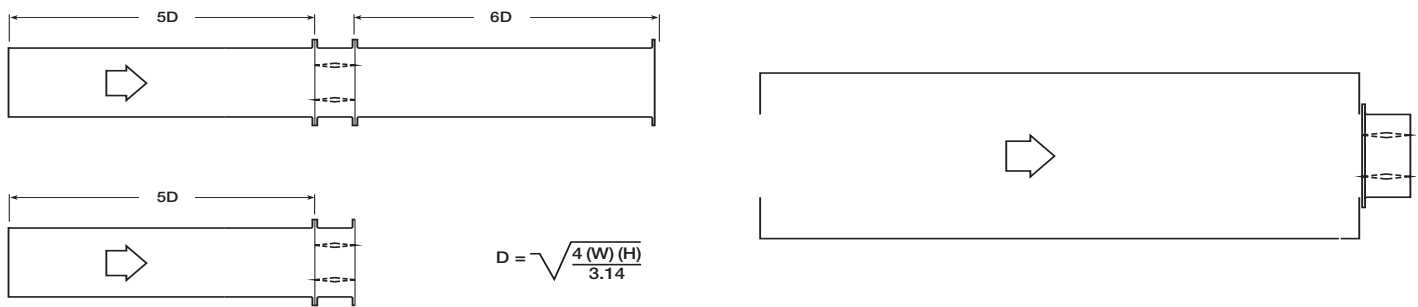

Pressure Drop
36 x 36 in. Damper
(914mm x 914mm)

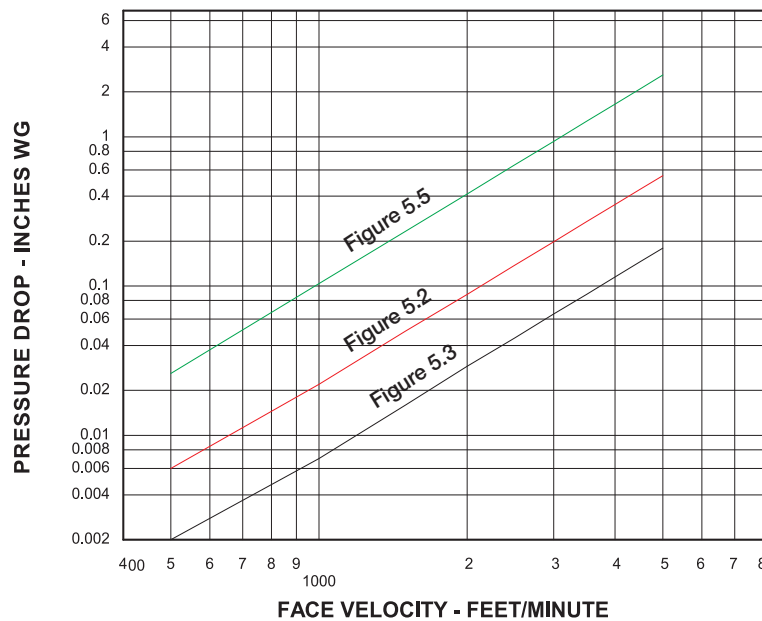

Leakage

Damper leakage (with blades fully closed) varies based on the type of low leakage seals applied. Model HCD-230LE is available with no jamb seals (standard) or with stainless steel jamb seals and EPDM, or silicone rubber blade seals. Leakage testing was conducted in accordance with AMCA Standard 500-D and is expressed as CFM per sq. ft. of damper face area. All data has been corrected to represent standard air at a density of .075 lb/ft³ (1.2 kg/m³).

Leakage
36 x 36 in. (914mm x 914mm) Damper
(based on 5 in. lb/ft² of torque)

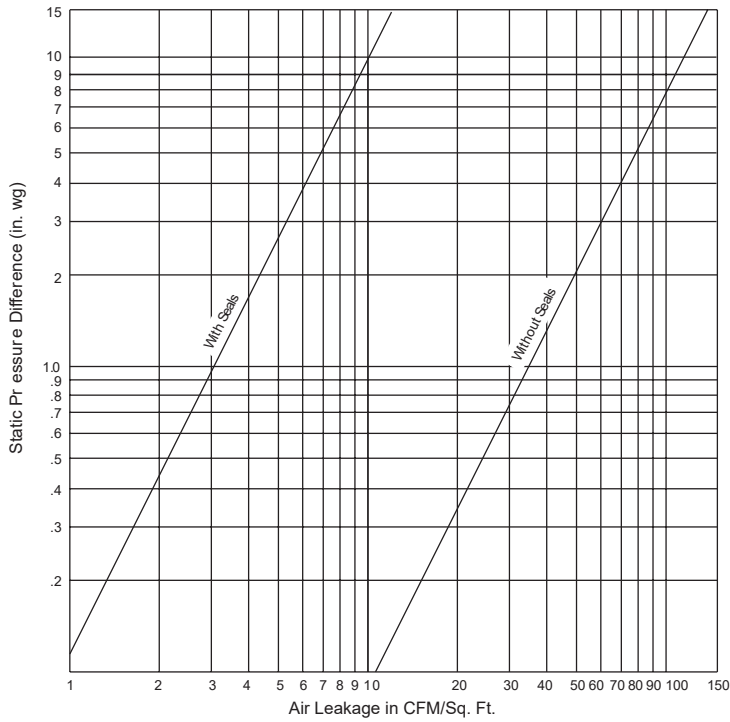

Limitations

Pressure Limitations

The chart at the right shows conservative pressure limitations based on a maximum blade deflection of $w/360$.

Temperature Limitations

Blade seals: Silicone -40° to 400°F (-40° to 204°C)
EPDM -20° to 250°F (-29° to 121°C)

Jamb seals: Flexible stainless steel -40° to 400°F
(-40° to 204°C)

For higher temperatures, consult factory.

Velocity Limitations

The chart at far right shows velocity limitations based on damper size.

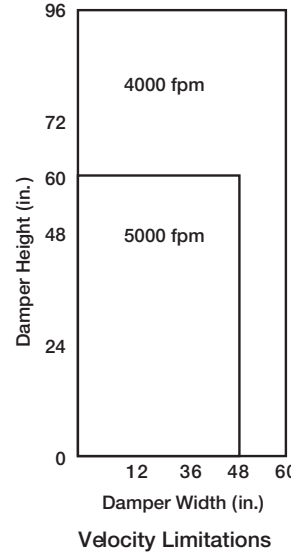
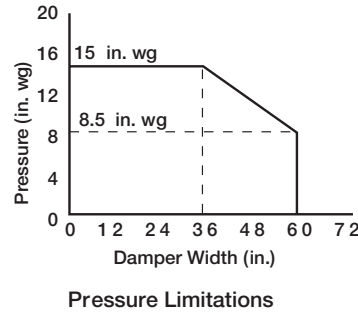

Document Links



[INSTALLATION](#)



[CATALOG](#)



[HD PRODUCT GUIDE](#)



[SELECTION GUIDE](#)



[WARRANTY](#)