

Application

Model HCDR-350 is a heavy duty round industrial control damper with a flanged style frame. It is designed to control airflow and provide shut off in HVAC or industrial process control systems. A variety of optional features allows the model HCDR-350 to be tailored to the application.

Damper Ratings

Velocity

Up to 6400 fpm (32.5 m/s)

Pressure

Up to 20 in. wg (5 kPa) - pressure differential

Temperature

-40°F to 1000°F (-40°C to 538°C). Consult factory for temperatures

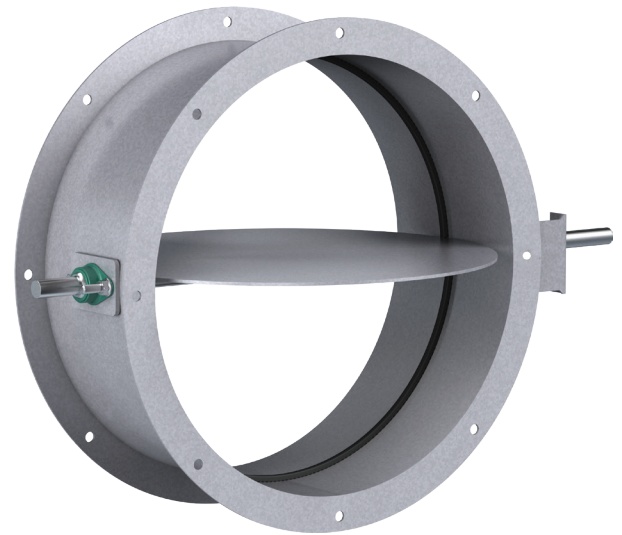

* Actual Inside Dimension

Size Limitations

W x H	Minimum Size	Maximum Size
Inches	4	72
mm	102	1829

Diameter D Inches (mm)		Frame Depth J Inches (mm)	Frame & Flange Gauge (mm)	Flange Width F Inches (mm)	Axle Diameter Inches (mm)	Blade Thickness Gauge (mm)
Above	Through					
3.99 (101)	12 (3305)	6 (152)	12 (2.7)	1.25 (32)	0.5* (13)	10 (3.5)
12 (305)	20 (508)	8 (203)	10 (3.5)	1.5 (38)	0.75 (19)	0.188 (4.8)
20 (508)	24 (610)	8 (203)	10 (3.5)	1.5 (38)	0.75 (19)	0.25 (6)
24 (610)	36 (914)	8 (203)	0.188 (4.8)	2.0 (51)	1 (25)	0.25 (6)
36 (914)	48 (1219)	8 (203)	0.188 (4.8)	2.0 (51)	1.25 (32)	0.25 (6)
48 (1219)	54 (1372)	10 (254)	0.188 (4.8)	2.5 (64)	1.50 (38)	0.25 (6)
54 (1372)	60 (1524)	10 (254)	0.25 (6)	2.5 (64)	1.50 (38)	0.25 (6)
60 (1524)	72 (1829)	10 (254)	0.25 (6)	3 (76)	2 (51)	0.25 (6)

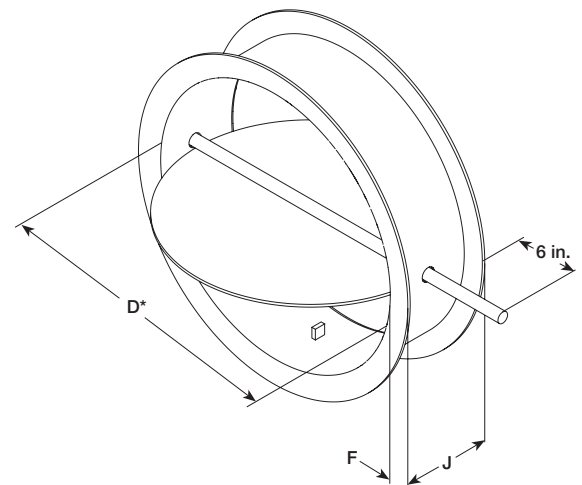

* The axle diameter is 3/4 in. (19mm) when outboard carbon bearings are selected for dampers 16 inches and below.

Construction Features - see page 2

Construction Features

	Frame Material	Frame Type	Blade Material	Blade Seals	Blade Stops	Blade Type	Axle Bearing	Axle Material	Axle Seals	Paint Finishes
Up to 400°F										
Standard	Painted	Flanged Channel	Painted	None	Pin Stop	Round Butterfly	External Bronze through 48 in. (1219mm); External Relubricable Ball above 48 in. (1219mm) diameter	Plated Steel	None	Hi Pro Polyester
Optional	304SS, 316SS		304SS, 316SS	EPDM, Silicone	Rolled Bar		External Ball, Outboard Bronze, Outboard Ball	303SS, 316SS	O-ring, Double Gland	Epoxy, Hi Temperature Flame Control, Hi Temperature Silver, Industrial Epoxy, Mill Finish (304SS, 316SS)
600°F										
Standard	Painted	Flanged Channel	Painted	None	Pin Stop	Round Butterfly	Outboard Bronze	Plated Steel	Double Gland	Hi Temperature Flame Control
Optional	304SS, 316SS		304SS, 316SS	Fiberglass, Ceramic	Rolled Bar		Outboard Ball, Outboard Carbon	303SS, 316SS	Outboard Double Gland*	-
800°F										
Standard	Painted	Flanged Channel	Painted	None	Pin Stop	Round Butterfly	Outboard Carbon	Plated Steel	Double Gland	Hi Temperature Flame Control
Optional	304SS, 316SS		304SS, 316SS	Fiberglass, Ceramic	Rolled Bar		-	303SS, 316SS	Outboard Double Gland*	-
1000°F										
Standard	304SS	Flanged Channel	304SS	None	Rolled Bar	Round Butterfly	Outboard Carbon	303SS	Double Gland	-
Optional	316SS		316SS	Ceramic	-		-	316SS	Outboard Double Gland*	-

*Outboard Double Gland assembly allows for 3 in. of insulation.

Features

- Wide mounting flanges can be ordered with bolt holes, customized to match your requirements.
- Rolled bar stops are required when blade seal is selected.
- Wide range of actuators available.

Options

Bearings and Shafts

External Mounted Ball or Sleeve Bearing (Bronze Sleeve Standard, Ball Optional)

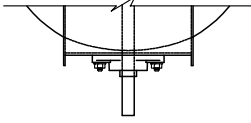

External Mounted Bronze Sleeve Bearing With O-Ring (Optional)

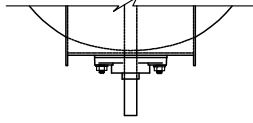

O-Ring Shaft Seal with Outboard Mounted Bearing (Optional)

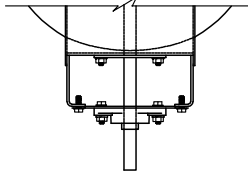

Double Gland Stuffing Box with Outboard Mounted Bearing (Optional)

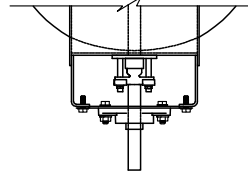

Insulated Outboard Double Gland Stuffing Box with Outboard Mounted Bearing (Optional)*

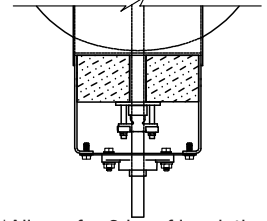

*Allows for 3 in. of insulation.

Blade Seal (Rolled Bar Blade Stops Required)

Standard - Does not include Blade Seals

Optional - EPDM Blade Seals (250°F [121°C] max.)

Optional - Silicone Rubber Blade Seals (400°F [204°C] max.)

Optional - Fiberglass Blade Seals (800°F [427°C] max.)

Optional - Ceramic Blade Seals (1000°F [538°C] max.)

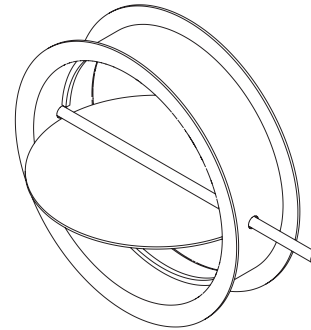

Bolt Holes

The recommended bolt hole pattern is shown in the table below. Customer must specify bolt holes that are parallel to the axle centerline or that straddle the axle centerline as shown in the diagrams below. The factory can also provide bolt hole sizes and patterns other than those shown.

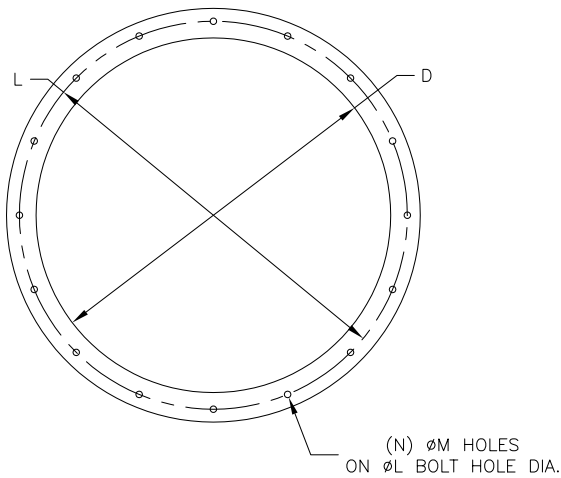

Recommended Bolt Hole Pattern (Bolt Holes Parallel to Axle Centerline)					
Diameter Inches (mm)		Number of Holes	Mounting Hole Diameter in. (mm) N	Bolt Circle Diameter L	Degrees Between Holes
Above	Through				
4 (102)	8 (203)	4	3/8 (9.5)	*	90
8.001 (203)	18 (457)	8	7/16 (11)	*	45
18.001 (457)	24 (610)	12	7/16 (11)	*	30
24.001 (610)	36 (914)	16	7/16 (11)	*	22 1/2
36.001 (914)	58 (1473)	24	7/16 (11)	*	15
58.001 (1473)	72 (1829)	32	9/16 (14)	*	11 1/4

* Bolt Circle Diameter = Damper Diameter + Flange Height + 1/4 in. (6mm)

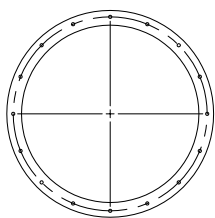

On Centerline

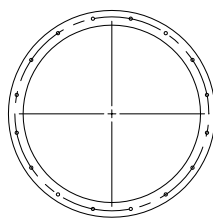

Straddle Centerline

Performance Data

AMCA Test Figure 5.3

Figure 5.3 illustrates a fully ducted damper. This configuration has low pressure drop because entrance and exit losses are minimized by straight duct runs upstream and downstream of the damper.

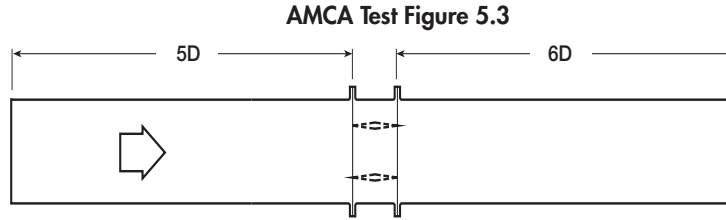

Pressure Drop Data

This pressure drop data was conducted in accordance with AMCA Standard 500-D using Test Figure 5.3. All data has been corrected to represent standard air at a density of 0.075 lb/ft³ (1.2 kg/m³).

Actual pressure drop found in any HVAC system is a combination of many factors. This pressure drop information along with an analysis of other system influences should be used to estimate actual pressure losses for a damper installed in a given HVAC system.

NOTE:

PS refers to damper with standard pin blade stop

BS refers to damper with rolled bar blade stop

12 inch diameter

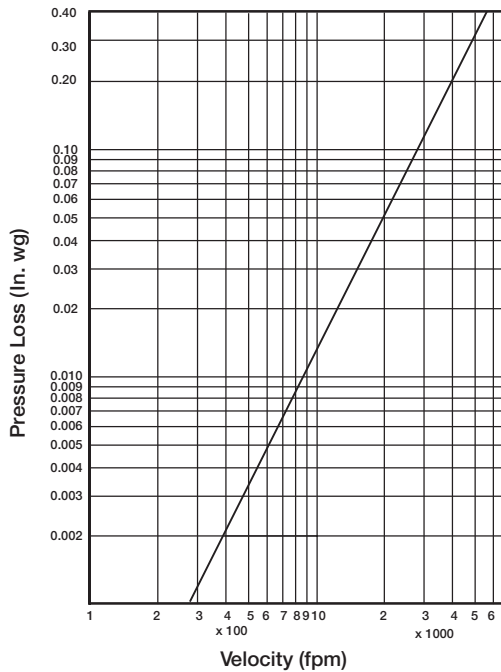

36 inch diameter

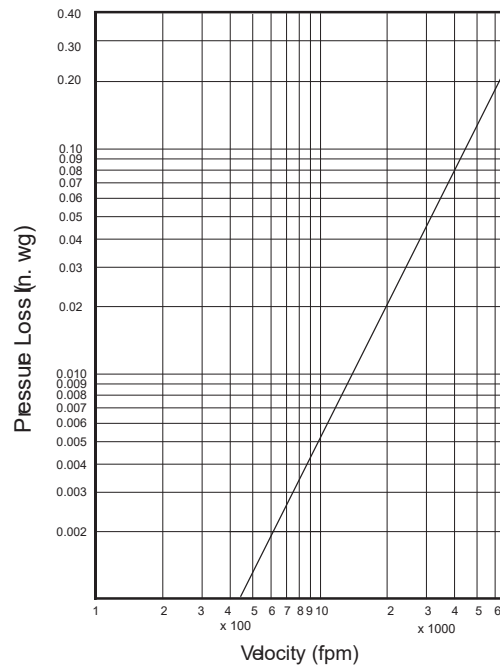

Leakage Data

Damper leakage (with blades fully closed) varies based on the type of blade stops and low leakage seals applied. Model HCDR-350 is available with no seals (standard) or with EPDM or silicone rubber blade seals. Leakage testing was conducted in accordance with AMCA Standard 500-D and is expressed as cfm/ft² of damper face area. All data has been corrected to represent standard air at a density of 0.075 lb/ft³ (1.2 kg/m³).

Leakage
12 in. Diameter Damper

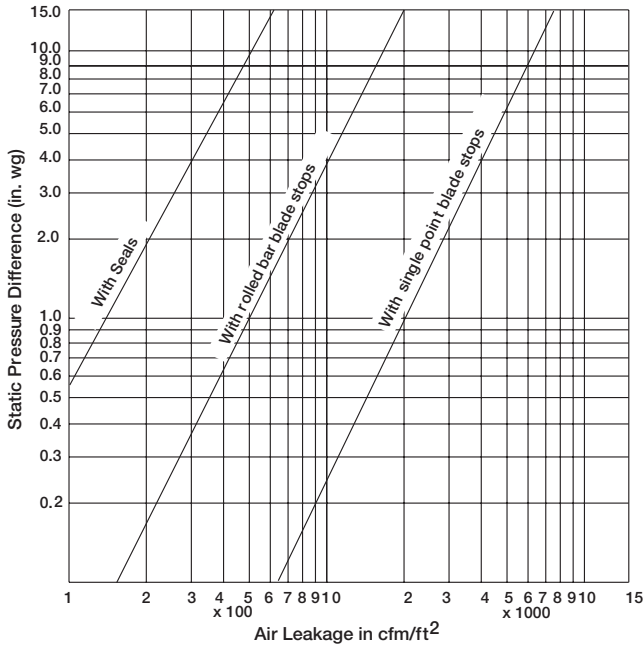

Leakage
36 in. Diameter Damper

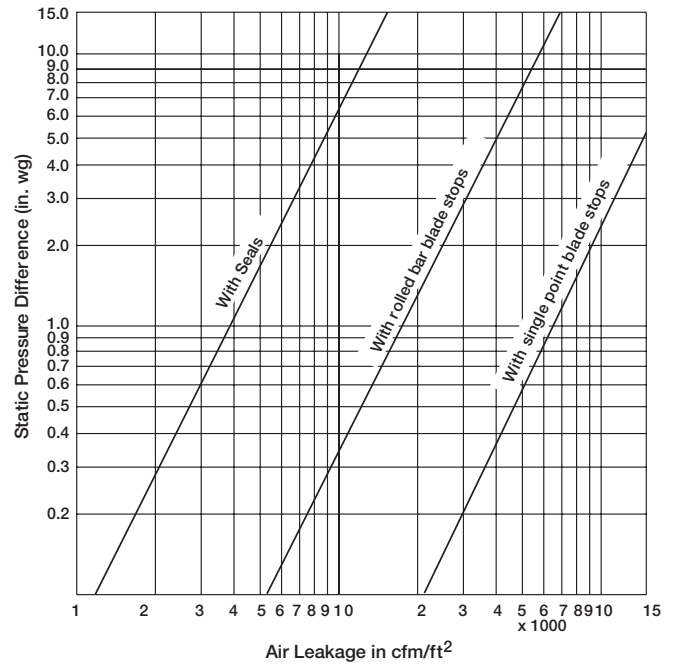

Document Links



[INSTALLATION](#)



[CATALOG](#)



[SELECTION GUIDE](#)



[WARRANTY](#)

