

Application

Model HCDR-450 is a heavy duty round industrial control damper with a flanged style frame. It is designed to control airflow and provide shut off in HVAC or industrial process control systems.

Ratings

Velocity

Up to 7000 fpm (36 m/s)

Temperature

-40° to 400°F (-40° to 204°C) See page 2

Pressure

Up to 30 in. wg (7 kPa) - differential pressure

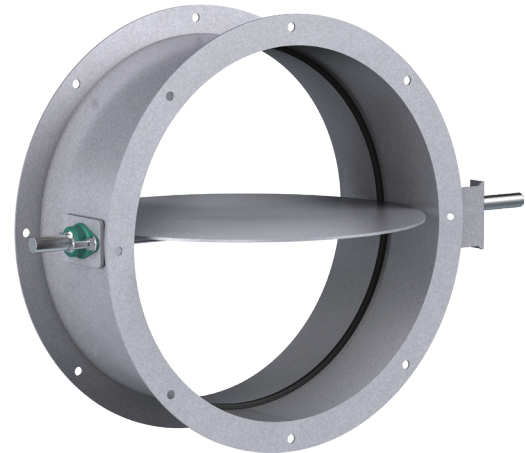

* Actual Inside Dimension

Construction

	Standard	Optional
Frame Material	Painted	304SS or 316SS
Frame Type	Flanged channel	
Blade Material	Painted	304SS or 316SS
Blade Seals	None	EPDM, Silicone
Blade Stop	Pin stop	Rolled bar
Blade Type	Round butterfly	
Axle Bearing	External bronze through 24 in. (610 mm); External ball above 24 in. (610 mm) diameter	External ball, Outboard bronze, Outboard ball
Axle Material	Plated steel	303SS or 316SS
Axle Seals	None	O-ring, Double gland
Paint Finishes	Hi Pro Polyester	Hi Temperature Flame Control, Hi Temperature Silver, Industrial Epoxy, None
Mounting Holes	None	Parallel, Straddle

Diameter	Minimum Size	Maximum Size
Inches	6	60
mm	152	1524

Features

- Wide mounting flanges can be ordered with bolt holes, customized to match your requirements.
- Rolled bar stops are required when blade seal is selected.
- Wide range of actuators available

Dimensions

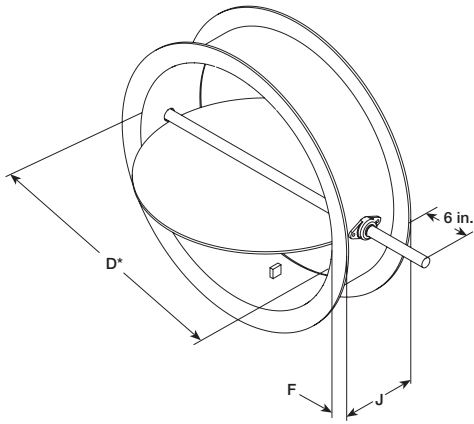

Diameter D Inches (mm)		Frame Depth J Inches (mm)	Frame & Flange Gauge (mm)	Flange Width F Inches (mm)	Axle Diameter Inches (mm)	Blade Thickness Gauge (mm)
Above	Through					
6 (152)	12 (305)	10 (254)	0.188 (4.8)	1.25 (32)	1 (25)	0.188 (4.8)
12 (305)	20 (508)	10 (254)	0.188 (4.8)	1.5 (38)	1.25 (32)	0.188 (4.8)
20 (508)	24 (610)	10 (254)	0.188 (4.8)	1.5 (38)	1.25 (32)	0.25 (6)
24 (610)	32 (813)	10 (254)	0.188 (4.8)	2 (51)	1.5 (38)	0.25 (6)
32 (813)	36 (914)	10 (254)	0.188 (4.8)	2 (51)	1.5 (38)	0.25 (6)
36 (914)	48 (1219)	10 (254)	0.188 (4.8)	2 (51)	2 (51)	0.25 (6)
48 (1219)	54 (1372)	10 (254)	0.188 (4.8)	2.5 (64)	2 (51)	0.25 (6)
54 (1372)	60 (1524)	10 (254)	0.25 (6)	2.5 (64)	2 (51)	0.25 (6)

Options

Bearings and Shafts

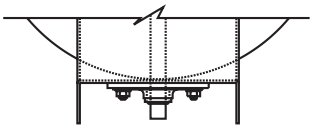

External Mounted Ball or Sleeve Bearing (Bronze Sleeve Standard, Ball Optional)

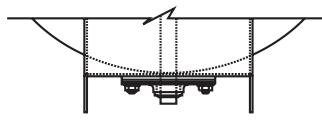

External Mounted Bronze Sleeve Bearing with O-Ring (Optional)

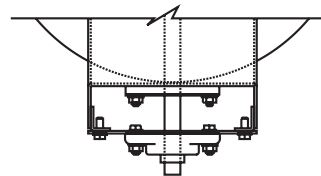

O-Ring Shaft Seal with Outboard Mounted Bearing (Optional)

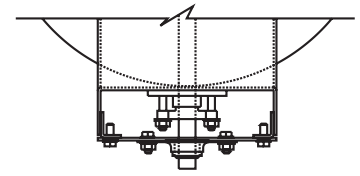

Double Gland Stuffing Box with Outboard Mounted Bearing (Optional)

Blade Seal (Rolled Bar Blade Stops Required)

Standard - Does not include Blade Seals

Optional - EPDM Blade Seals (250°F [121°C] max.)

Optional - Silicone Rubber Blade Seals (400°F [204°C] max.)

Optional - Fiberglass Blade Seals (800°F [427°C] max.)

Optional - Ceramic Blade Seals (1000°F [538°C] max.)

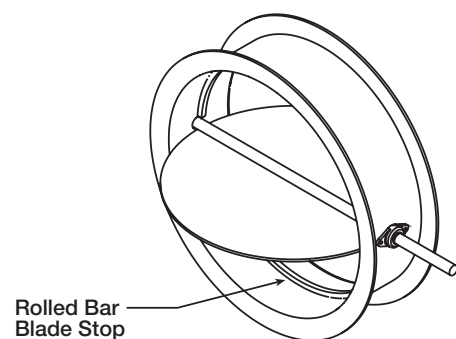

Mounting Holes

The recommended bolt hole pattern is shown in the table below. Customer must specify bolt holes that are parallel to the axle centerline or that straddle the axle centerline as shown in the diagrams below. The factory can also provide bolt hole sizes and patterns other than those shown.

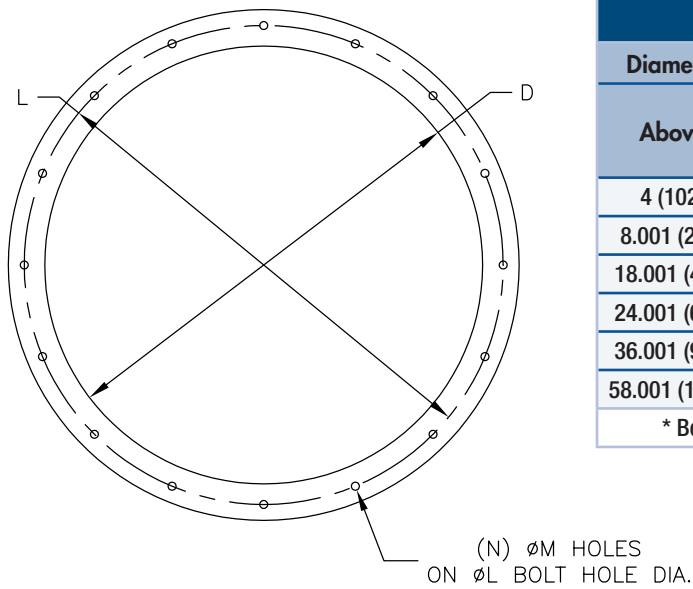

Recommended Bolt Hole Pattern (Bolt Holes Parallel to Axle Centerline)					
Diameter Inches (mm)		Number of Holes	Mounting Hole Diameter in. (mm) N	Bolt Circle Diameter L	Degrees Between Holes
Above	Through				
4 (102)	8 (203)	4	3/8 (9.5)	*	90
8.001 (203)	18 (457)	8	7/16 (11)	*	45
18.001 (457)	24 (610)	12	7/16 (11)	*	30
24.001 (610)	36 (914)	16	7/16 (11)	*	22½
36.001 (914)	58 (1473)	24	7/16 (11)	*	15
58.001 (1473)	72 (1829)	32	9/16 (14)	*	11¼

* Bolt Circle Diameter = Damper Diameter + Flange Height + ¼ in. (6mm)

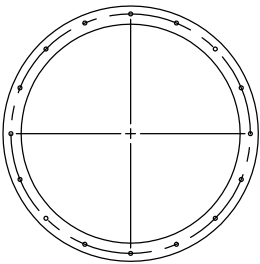

On Centerline

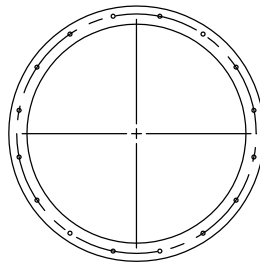

Straddle Centerline

Performance Data

AMCA Test Figure 5.3

Figure 5.3 illustrates a fully ducted damper. This configuration has low pressure drop because entrance and exit losses are minimized by straight duct runs upstream and downstream of the damper.

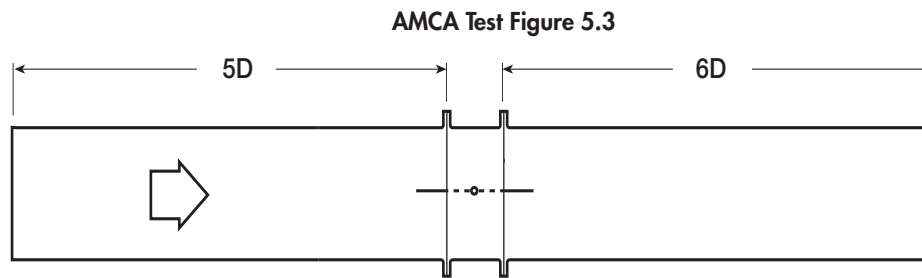

Pressure Drop Data

This pressure drop data was conducted in accordance with AMCA Standard 500-D using Test Figure 5.3. All data has been corrected to represent standard air at a density of 0.075 lb/ft^3 (1.2 kg/m^3).

Actual pressure drop found in any HVAC system is a combination of many factors. This pressure drop information along with an analysis of other system influences should be used to estimate actual pressure losses for a damper installed in a given HVAC system.

NOTE:

PS refers to damper with standard pin blade stop

BS refers to damper with rolled bar blade stop

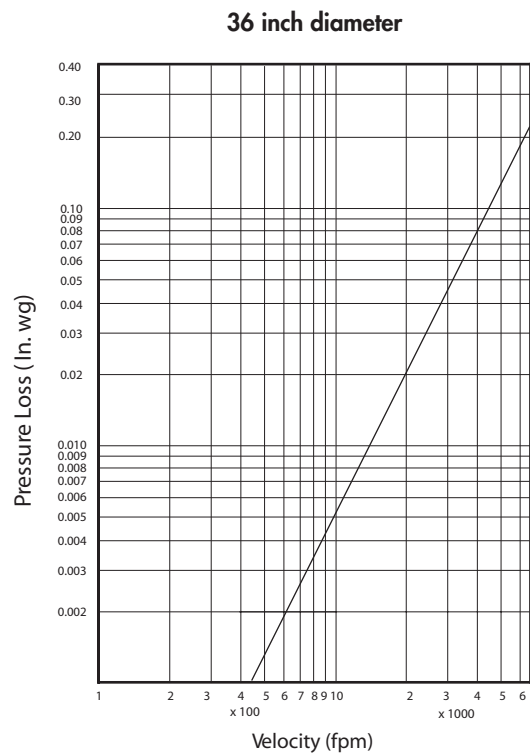
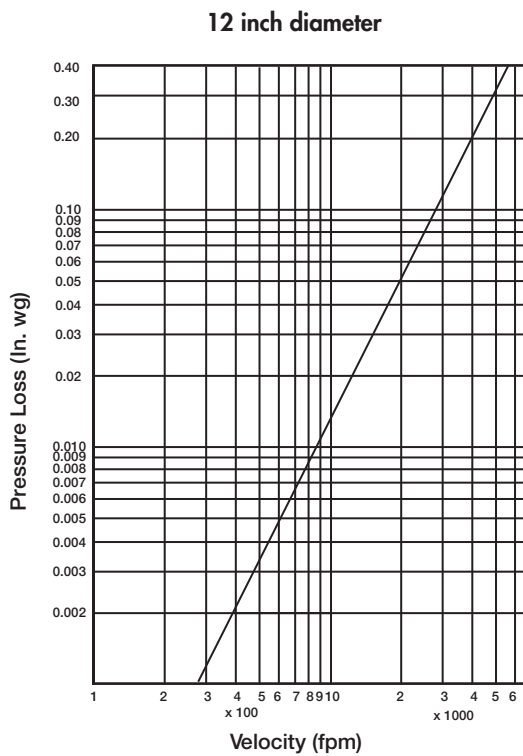

Leakage

Damper leakage (with blades fully closed) varies based on the type of blade stops and low leakage seals applied. Model HCDR-450 is available with no seals (standard) or with EPDM or silicone rubber blade seals. Leakage testing was conducted in accordance with AMCA Standard 500-D and is expressed as cfm/ft² of damper face area. All data has been corrected to represent standard air at a density of 0.075 lb/ft³ (1.2 kg/m³).

Leakage
12 in. Diameter Damper

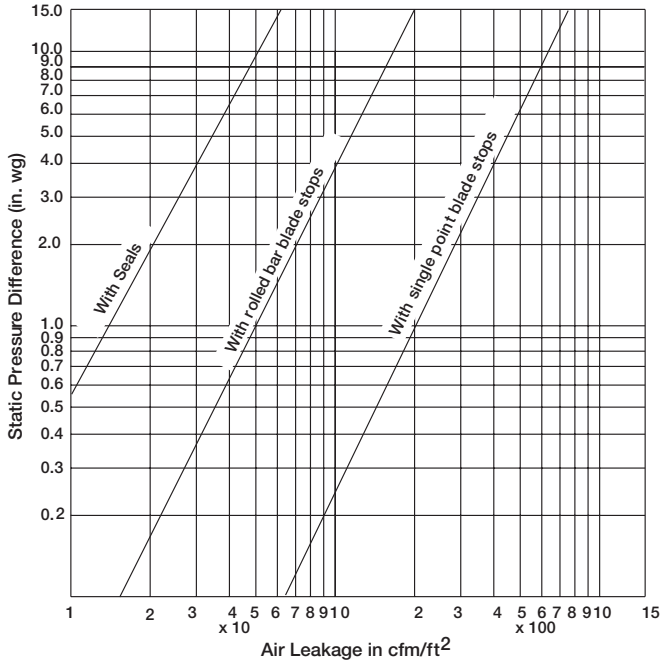

Leakage
36 in. Diameter Damper

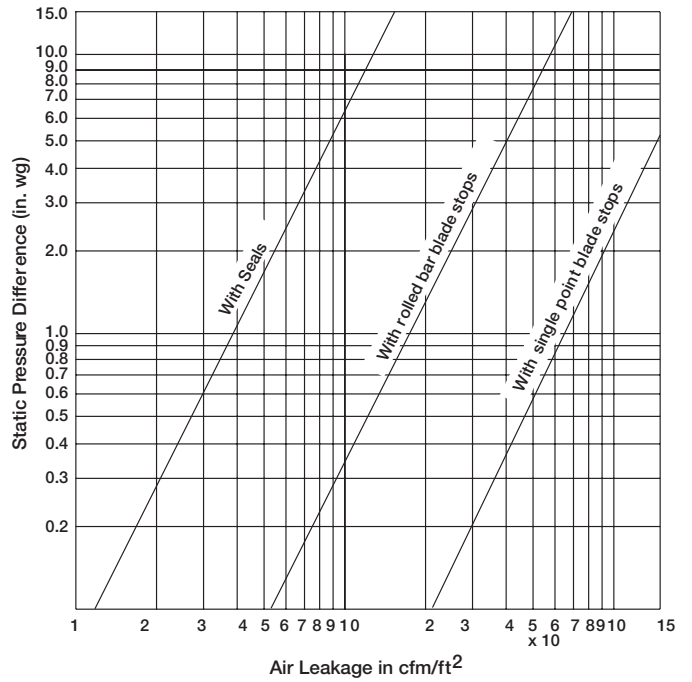

Document Links

[Installation Instructions](#)



[Heavy Duty/Industrial Damper Catalog](#)



[Heavy Duty and Industrial Product Selection Guide](#)



[Damper Interactive Selection Guide](#)



[Warranty](#)

