

Application

The WD-100 series are horizontally mounted backdraft dampers designed to allow vertical airflow up and prevent reverse airflow. The dampers are opened by air pressure differential (assisted by springs on sizes over 12 in. x 12 in. [305 mm]) and closed by gravity. Optional motor pack converts the dampers to motorized operation. The primary application is with roof mounted exhaust fans.

Ratings

Velocity

Up to 2500 fpm (13 m/s)

Pressure

Up to 1.0 in. wg (0.25 kPa) - differential pressure

Temperature

Up to 180°F (82°C)



* W & H dimensions of each section are furnished approximately 1/8 in. (3mm) undersize.

Construction

	Standard
Frame Material	Galvanized steel
Frame Thickness	18 ga. (1.3mm)
Frame Type	No Flange (WD-100)
	Flange on Discharge (WD-110)
	Flange on Intake (WD-120)
Blade Material	Roll formed aluminium
Blade Thickness	0.025 in. (0.64mm)
Blade Seals	Vinyl
Axle	3/16 in. (4.8mm) dia. zinc plated steel, full length
Axle Bearings	Synthetic
Linkage Material	Galvanized steel

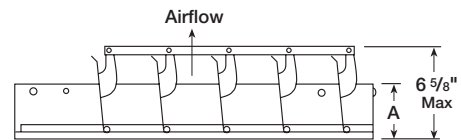
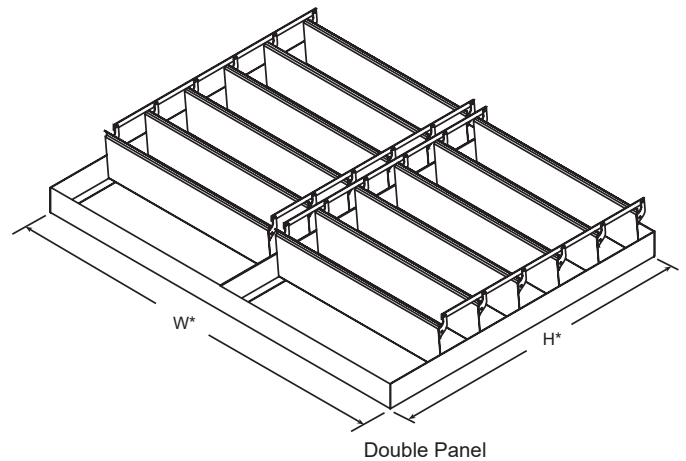

Model WD-100
No Flange

A = 2 1/2 in. (64mm) when damper width **and** height is less than 36 in. (914mm)
3 1/2 in. (89mm) when width **or** height is greater than 36 in. (914mm)

Size Limitations

W x H	Minimum Size	Maximum Size	
		Single Panel	Multiple Panels
Inches	6 x 6	36 x 74	144 x 148
mm	152 x 152	914 x 1880	3568 x 3759

Options and Accessories

- Motor packs (24V, 120V, 208V, 220V, and 460V)
- End switch kit (see page 3): part no. 851038

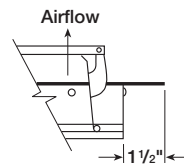

Model WD-110
Flange on discharge side

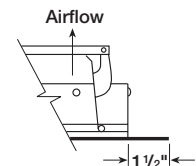

Model WD-120
Flange on intake side

Performance Data

Pressure Drop

Performance data results from testing a 36 in. x 36 in. (914mm x 914mm) damper in accordance with AMCA Standard 500-D using Figure 5.7B (unducted). All data has been corrected to represent standard air at 0.075 lb/ft³ (1.201 kg/m³).

Operational Data		ΔP in. wg (Pa)	Velocity fpm (m/s)
Blades start to open	Non-ducted	0.01 (2.5)	40 (0.2)
Blades fully open	Non-ducted	0.10 (25)	813 (4)

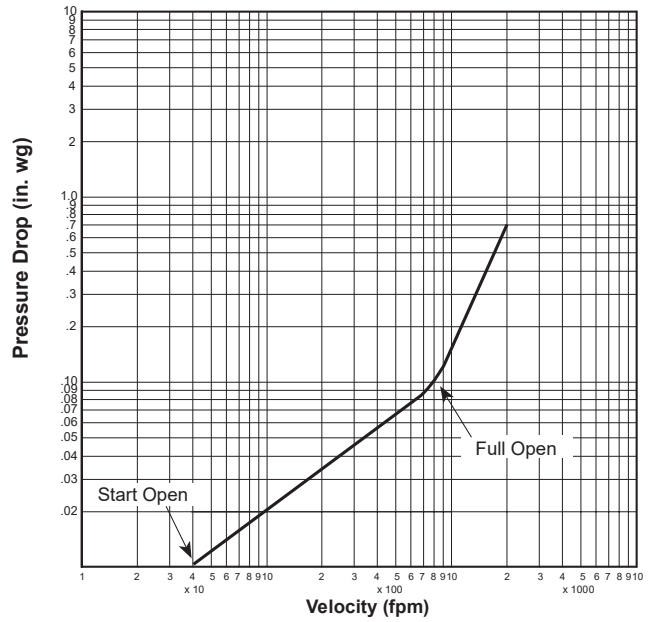

Leakage

Leakage testing was conducted in accordance with AMCA Standard 500-D and is expressed as CFM per sq. ft. of damper face area. All data has been corrected to represent standard air at 0.075 lb/ft³ (1.201 kg/m³).

Leakage

36 in. x 36 in. (914mm x 914mm) Damper

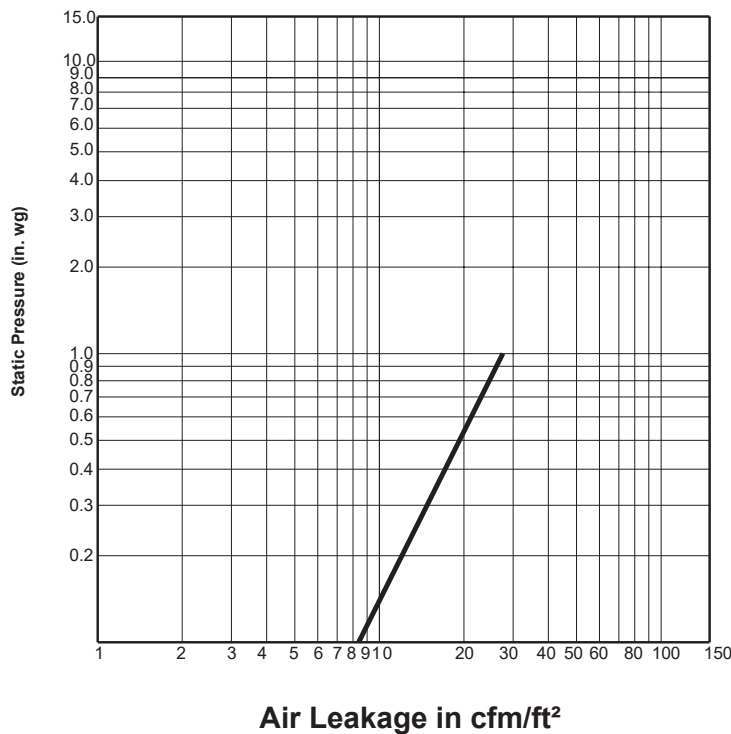

End Switch Kit and Motor Packs

End Switch Kit (Optional)

An end switch is a control device used in conjunction with a motor pack (the end switch is usually wired to a fan and/or to a light serving as an open/not open indicator). When the damper is powered open, the blades of the damper hit the spring rod of the end switch which in turn makes a connection allowing power to flow to the fan and/or light. This set up would be used when it is desirable to ensure that the damper is fully open before the fan starts. Otherwise, with the damper blades are not fully open, the pressure and air velocity produced by the fan may damage the blades, making the damper inoperable.

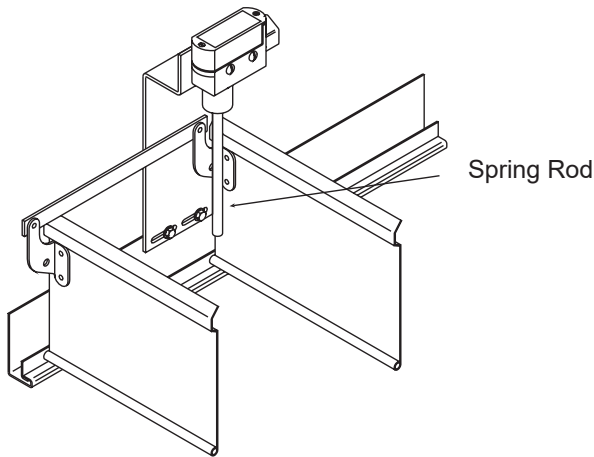

Horizontally Mounted Damper

MP-100 Motor Packs (Optional)

Model MP-100 motor packs may be field installed to convert the WD-100 horizontal mount backdraft damper to motorized operation. Airflow direction should remain vertical upward when this motorized version is applied. These versatile motor packs feature power opening with spring return. The springs also provide damper closure in the event of electrical failure. Voltages available are 24, 120, 208, 220, and 440. 575/600 volts may be used with a transformer and a 120V motor pack. All MP-100 motorpacks are UL listed.

If optional motor packs are desired, first determine the number of damper panels required for your installation (refer to page 4). Oversized applications may require several damper panels connected together for one opening. One motor pack is required for each damper panel (single or double). For example, a 120 in. x 60 in. (3048mm x 1524mm) WD-100 would consist of four single panel sections with each panel requiring a motor pack (4 motor packs total).

MP-100 motor packs are supplied with mounting hardware, assembly instructions and actuator arms for either single or double panel installation.

Motorpacks	24V (50/60 Hz)	440V (60Hz)	110V-120V (50/60Hz)	208V - 240V 50/60Hz
Stall Amps	.66	.041	.15	.07
Spec ID#	G24	G460	G110-240	G110-240

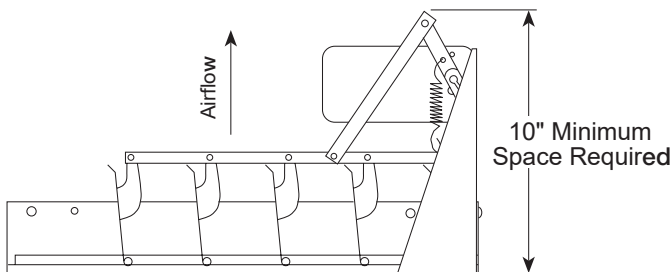

WD-100 backdraft damper with optional motorpack

WD-100 series dampers are available with an optional motor pack (MP-100). The diagram to the left illustrates the minimum space required for proper operation of a mounted motor pack.

WD-100 Selection

Multiple section dampers shown below are supplied as equal size sections. Any damper that has multiple sections, both vertically and horizontally, will require field assembly and will require additional reinforcement (not supplied by factory) to support the assembly. These larger dampers must have the additional reinforcement to give them structural stability.

Note : The width dimension is always parallel to the length of the blades.

Optional - The motor pack quantities are shown below for job specifications requesting them. The damper sizes shown are based on nominal size.

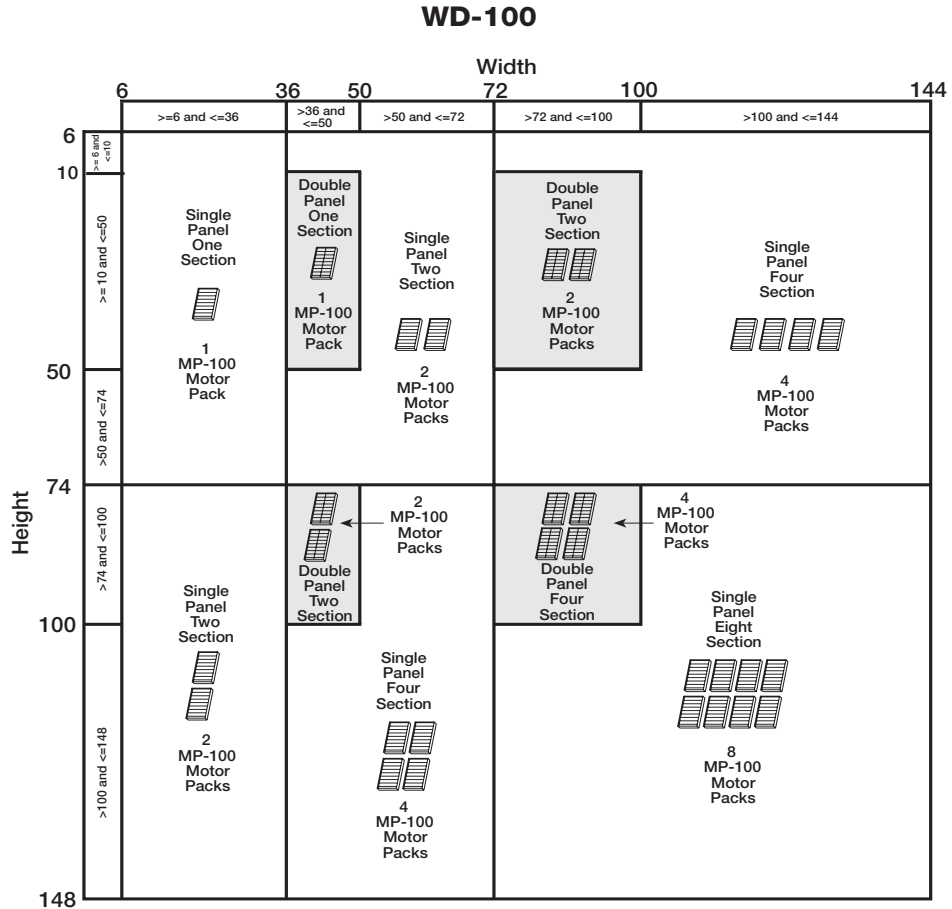

Document Links



[CATALOG](#)



[SELECTION GUIDE](#)



[WARRANTY](#)